

**PREINSTALLATION
VORINSTALLATION**

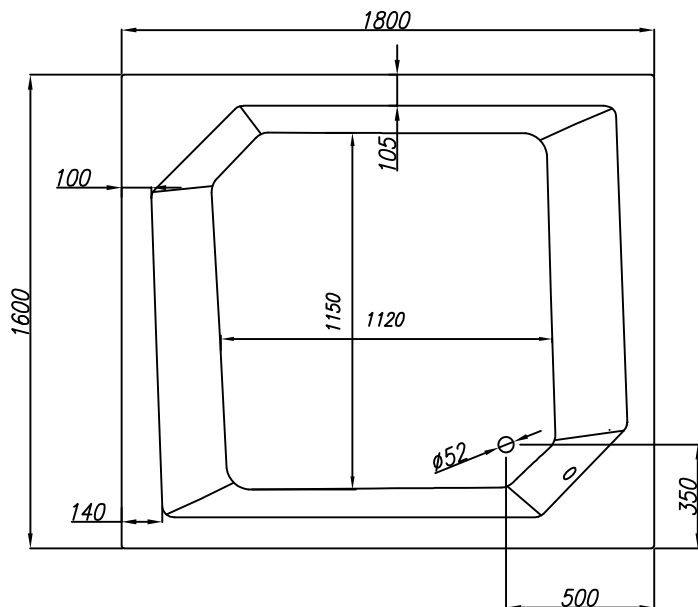
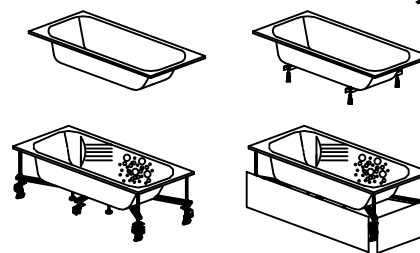
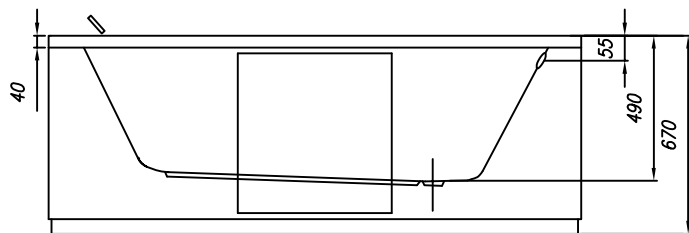

VOLUME (l)
VOLUMEN (l)

MAX. LOAD (kg)
MAX. BELASTUNG (kg)

FLOOR LOAD (kg/m²)
BODENBELASTUNG (kg/m²)

650

990

340

- - Spot for el. cable 3×2.5mm², length approx. 1m
- Platz Stromkabel 3 × 2,5 mm², Länge cca. 1 m
- - Spot for el. cable 1×6mm² for earthing, length approx. 1.5m
- Platz Stromkabel 1 × 6 mm² für Erdung, Länge cca. 1,5 m

- ⊠ - Connection of hot and cold water 1/2" min 0.2Mpa, max 0.4Mpa
- Anschluss Warm- und Kaltwasser 1/2" min 0,2 Mpa, max 0,4 Mpa







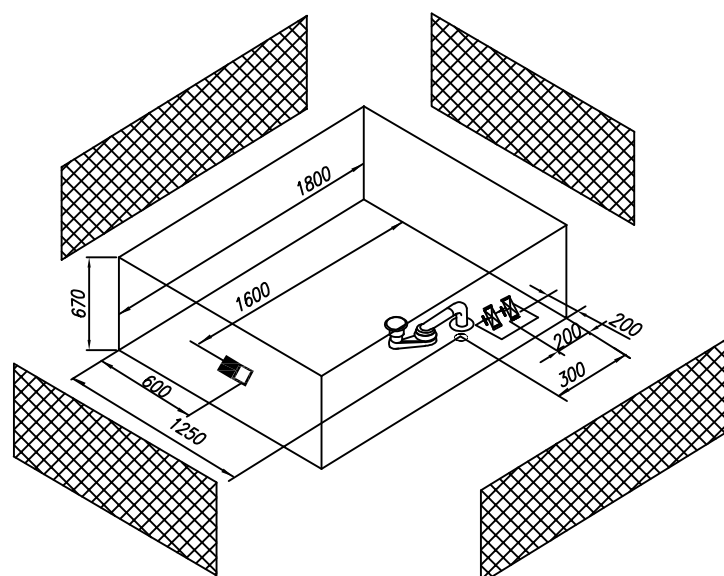

- - Drain spot Ø 50mm
- Abflussplatz Ø 50 mm

- ▨ - Panel - option
- Möglichkeit - Schürze

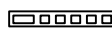
**INSTALLATION RECOMMENDATION
MONTAGEEMPFEHLUNG**



Recommended overflow set Vorgeschlagene Überlaufgarnitur	PAL 650
Recommendations for the installation of bathtub without panel Empfehlungen für die Montage von Badewannen ohne Schürze	Nr. MK 03
Recommendations for the installation of bathtub with panel Empfehlungen für die Montage von Badewannen mit Schürze	Nr. MK 01
Option of the built-in bathtub base Möglichkeit des Sockels für die Badewannen ohne Schürze	Nr. MK 10 PKK 800-2x
Option of the bathtub base with panel Möglichkeit des Sockels für die Badewannen mit Schürze	pre-assembled vormontiert

-  - PUMP
- WASSERPUMPE
-  - WATER JETS
- WASSERDÜSEN
-  - AIR CONTROLLER
- LUFTREGLER
-  - ELECTRONIC SWITCHES
- ELEKTROSCHALTER
-  - FIXTURE AND SHOWER HANDLE
- WASSERHAHN UND DUSCHE
-  - BLOWER
- LUFTPUMPE
-  - AIR JET
- LUFTDÜSE
-  - SUCTION JET
- SAUGDÜSE
-  - LIGHT OR CHROMOTHERAPY
- LICHT- ODER CHROMOTHERAPIE
-  - MICROJET SWITCH
- SCHALTER FÜR MIKRODÜSEN

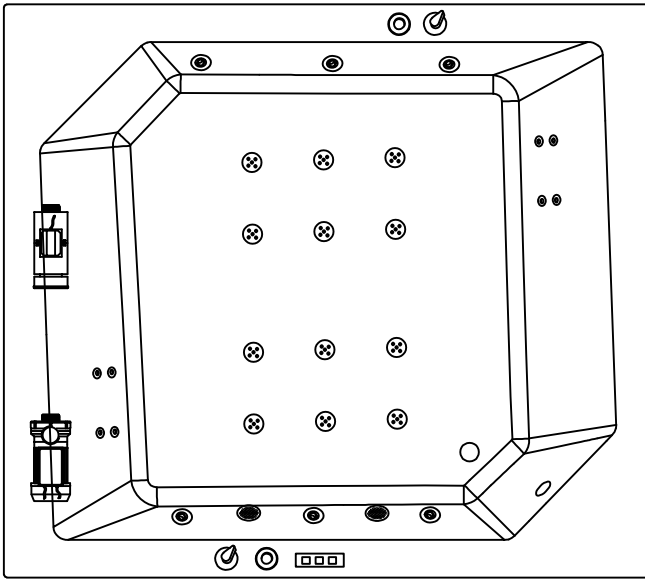

WATER AND AIR MASSAGE SYSTEM

- PUMP P=1250W
- BLOWER P=800W
- ELECTRONIC SWITCH
- 6 SUPER WATER JETS
- 12 AIR JETS
- 2 AIR REGULATORS
- 2x4 MICROJETS

WASSER UND LUFT MASSAGESYSTEM

- WASSERPUMPE P = 1250 W
- LUFTPUMPE P = 800 W
- ELEKTROSCHALTER
- 6 SUPER-WASSERDÜSEN
- 12 LUFTDÜSEN
- 2 LUFTREGLER
- 2x4 MIKRODÜSEN

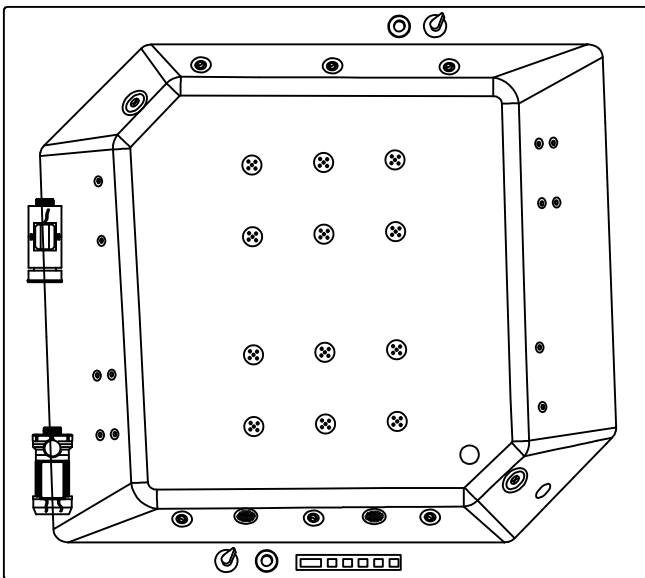

VITAL MASSAGE SYSTEM

- PUMP P=1250W
- BLOWER P=800W
- HEATER P=1500W
- ELECTRONIC SWITCH
- 2 AIR CONTROLLERS
- 6 SUPER WATER JETS
- 12 AIR JETS
- OZONE FOR DISINFECTION
- CHROMOTHERAPY
- 2x4 MICROJETS FOR BACK
- 2x2 MICROJETS FOR FEET

VITAL MASSAGESYSTEM

- WASSERPUMPE P = 1250 W
- LUFTPUMPE P = 800 W
- HEIZKÖRPER P = 1500 W
- ELEKTROSCHALTER
- 2 LUFTREGLER
- 6 SUPER WASSERDÜSEN
- 12 LUFTDÜSEN
- OZON FÜR DESINFEKTION
- CHROMOTHERAPIE
- 2x4 MIKRODÜSEN FÜR RÜCKEN
- 2x2 MIKRODÜSEN FÜR FÜSSE

3.

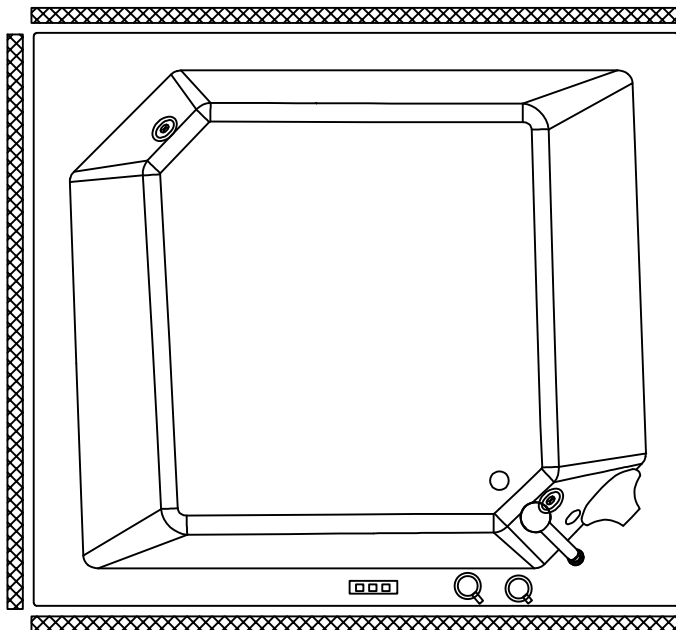

4.

- OPTION FIXTURE AND SHOWER HANDLE - MÖGLICHKEIT WASSERHAHN UND DUSCHE

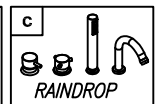
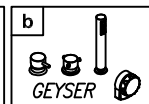
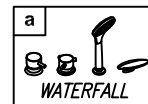
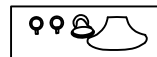

- OPTION CHROMOTHERAPY - MÖGLICHKEIT CHROMOTHERAPIE



- OPTION PANEL FOR BATHTUB - OPTION SHÜRZE FÜR BADEWANNE

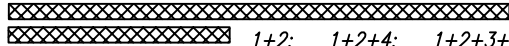

1+2; 1+2+4; 1+2+3+4

2.

1.