

**PREINSTALLATION
VORINSTALLATION**

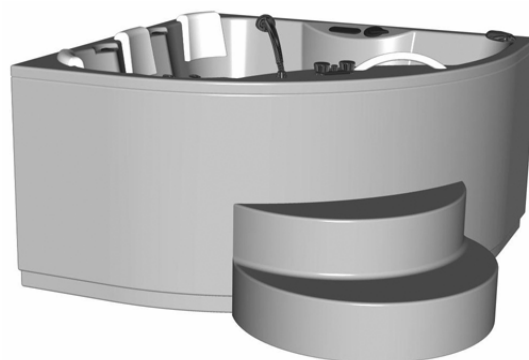
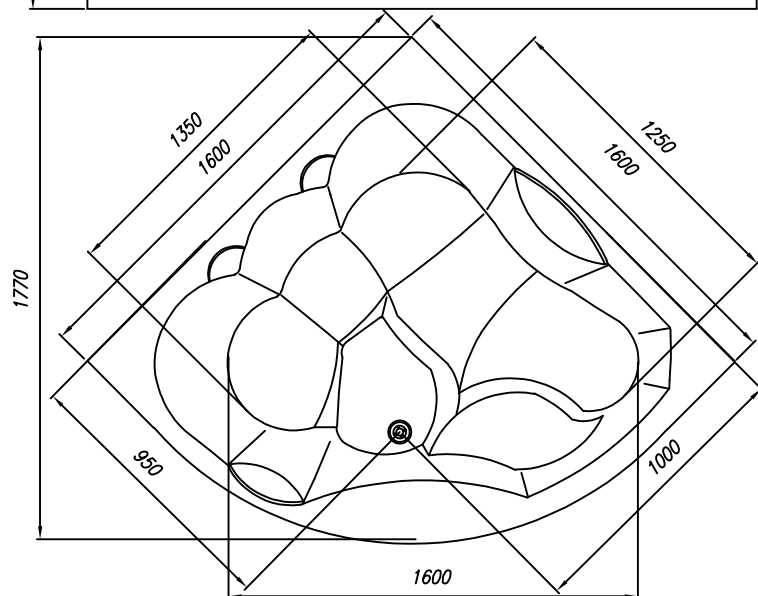
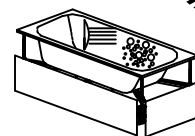
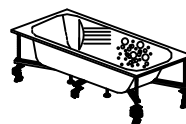
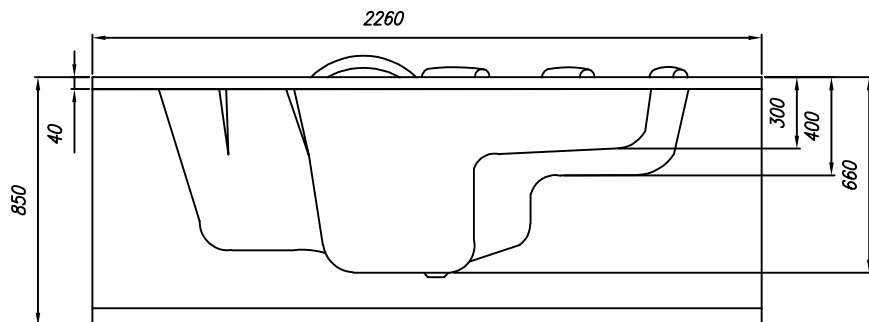

VOLUME (l)
VOLUMEN (l)

MAX. LOAD (kg)
MAX. BELASTUNG (kg)

FLOOR LOAD (kg/m²)
BODENBELASTUNG (kg/m²)

550

900

430

- - Spot for el. cable 3×2.5mm², length approx. 1m
- Platz Stromkabel 3 × 2,5 mm², Länge cca. 1 m
- - Spot for el. cable 1×6mm² for earthing, length approx. 1.5m
- Platz Stromkabel 1 × 6 mm² für Erdung, Länge cca. 1,5 m



- Connection of hot and cold water 1/2" min 0.2Mpa, max 0.4Mpa
- Anschluss Warm- und Kaltwasser 1/2" min 0,2 Mpa, max 0,4 Mpa



- Drain spot Ø 50mm
- Abflussplatz Ø 50 mm



- Panel - option
- Möglichkeit - Schürze

- OPTION STEP - ACRYL
- MÖGLICHKEIT TRITT - ACRYL

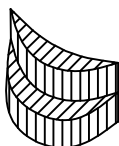

**INSTALLATION RECOMMENDATION
MONTAGEEMPFEHLUNG**

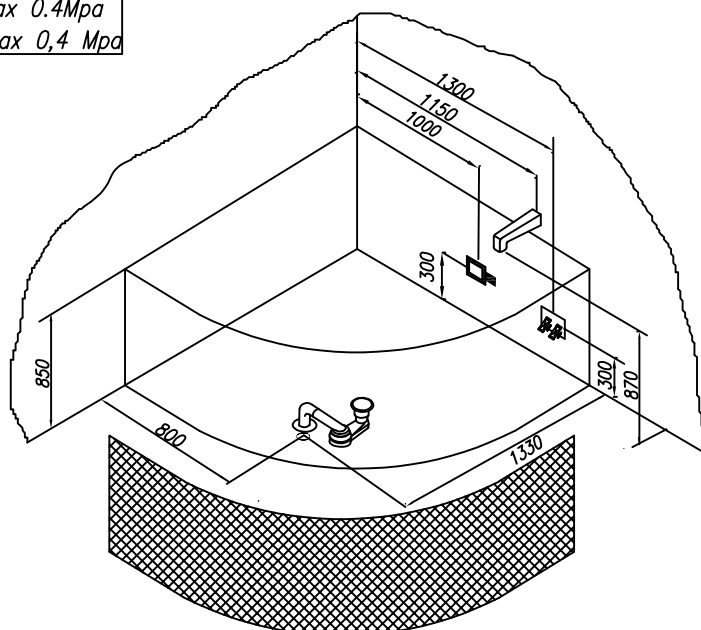

Recommendations for the installation of bathtub without panel Empfehlungen für die Montage von Badewannen ohne Schürze	Nr. MK 02
Recommendations for the installation of bathtub with panel Empfehlungen für die Montage von Badewannen mit Schürze	Nr. MK 01
Option of the bathtub base with panel Möglichkeit des Sockels für die Badewannen mit Schürze	pre-assembled vormontiert

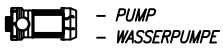

- PUMP
- WASSERPUMPE

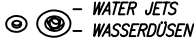

- WATER JETS
- WASSERDÜSEN



- AIR CONTROLLER
- LUFTREGLER

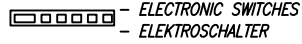

- ELECTRONIC SWITCHES
- ELEKTROSCHALTER



- FIXTURE AND SHOWER HANDLE
- WASSERHAHN UND DUSCHE

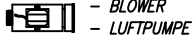

- BLOWER
- LUFTPUMPE

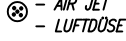

- AIR JET
- LUFTDÜSE

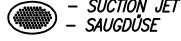

- SUCTION JET
- SAUGDÜSE

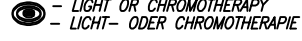

- LIGHT OR CHROMOTHERAPY
- LICHT- ODER CHROMOTHERAPIE

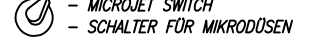

- MICROJET SWITCH
- SCHALTER FÜR MIKRODÜSEN

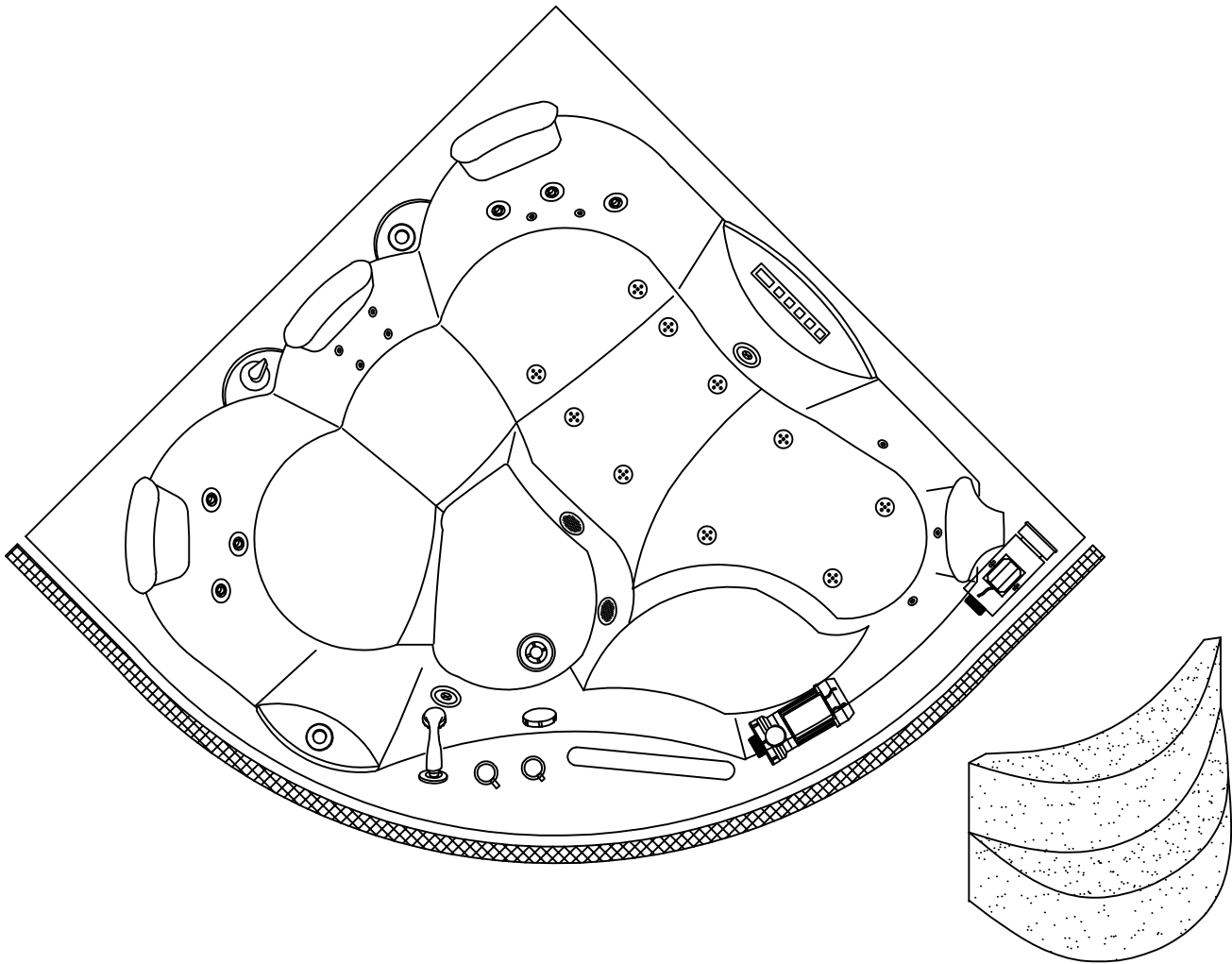

VITAL MESSAGE SYSTEM

- PUMP P=1250W
- BLOWER P=800W
- HEATER P=1500W
- ELECTRONIC SWITCH
- 2 AIR CONTROLLERS
- 6 SUPER WATER JETS
- 10 AIR JETS
- OZONE FOR DISINFECTION
- CHROMOTHERAPY
- 9 MICROJETS FOR BACK
- FIXTURE AND SHOWER HANDLE

VITAL MASSAGESYSTEM

- WASSERPUMPE P = 1250 W
- LUFTPUMPE P = 800 W
- HEIZKÖRPER P = 1500 W
- ELEKTROSCHALTER
- 2 LUFTREGLER
- 6 SUPER WASSERDÜSEN
- 10 LUFTDÜSEN
- OZON FÜR DESINFEKTION
- CHROMOTHERAPIE
- 9 MIKRODÜSEN FÜR RÜCKEN
- WASSERHAHN UND DUSCHE

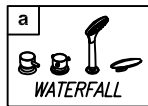
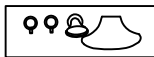

WATERFALL

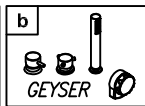

GEYSER

- OPTION PANEL FOR BATHTUB

- OPTION SHÜRZE FÜR BADEWANNE

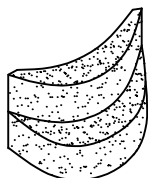

- OPTION STEP - ACRYL
- MÖGLICHKEIT TRITT - ACRYL